



Cambridge IGCSE™

CANDIDATE
NAME

CENTRE
NUMBER

--	--	--	--	--

CANDIDATE
NUMBER

--	--	--	--



COMBINED SCIENCE

0653/32

Paper 3 Theory (Core)

February/March 2022

1 hour 15 minutes

You must answer on the question paper.

No additional materials are needed.

INSTRUCTIONS

- Answer **all** questions.
- Use a black or dark blue pen. You may use an HB pencil for any diagrams or graphs.
- Write your name, centre number and candidate number in the boxes at the top of the page.
- Write your answer to each question in the space provided.
- Do **not** use an erasable pen or correction fluid.
- Do **not** write on any bar codes.
- You may use a calculator.
- You should show all your working and use appropriate units.

INFORMATION

- The total mark for this paper is 80.
- The number of marks for each question or part question is shown in brackets [].
- The Periodic Table is printed in the question paper.

This document has **24** pages. Any blank pages are indicated.

1 (a) Fig. 1.1 is a diagram of a root hair cell.

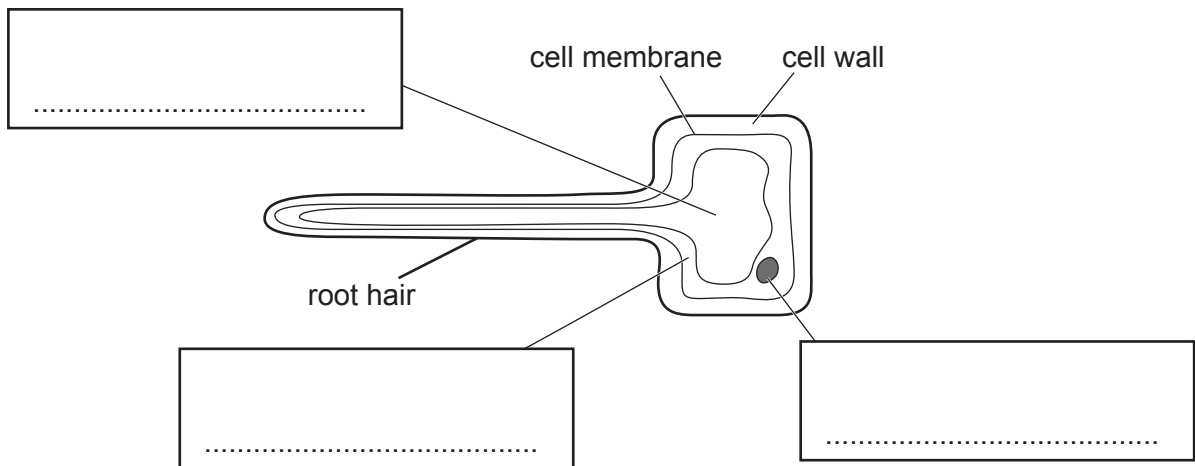

Fig. 1.1

(i) Complete the labels on Fig. 1.1. [3]

(ii) State the function of the cell wall.

..... [1]

(iii) Water enters the root hair cell and passes to the leaves of the plant.

Complete the flow chart to show the pathway of water through the plant.

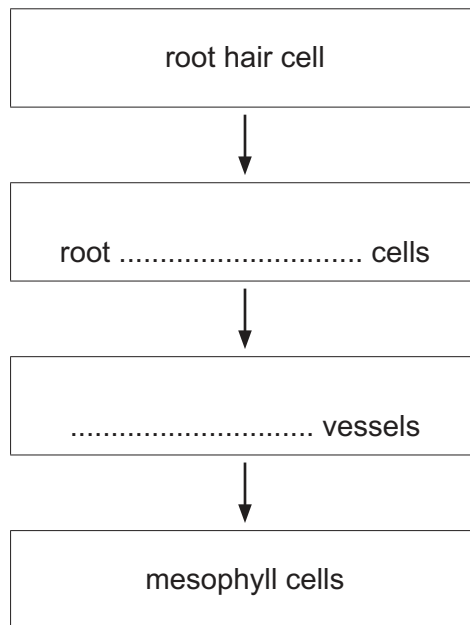

[2]

(b) Fig. 1.2 shows a plant cell before and after it is immersed in a concentrated sugar solution.

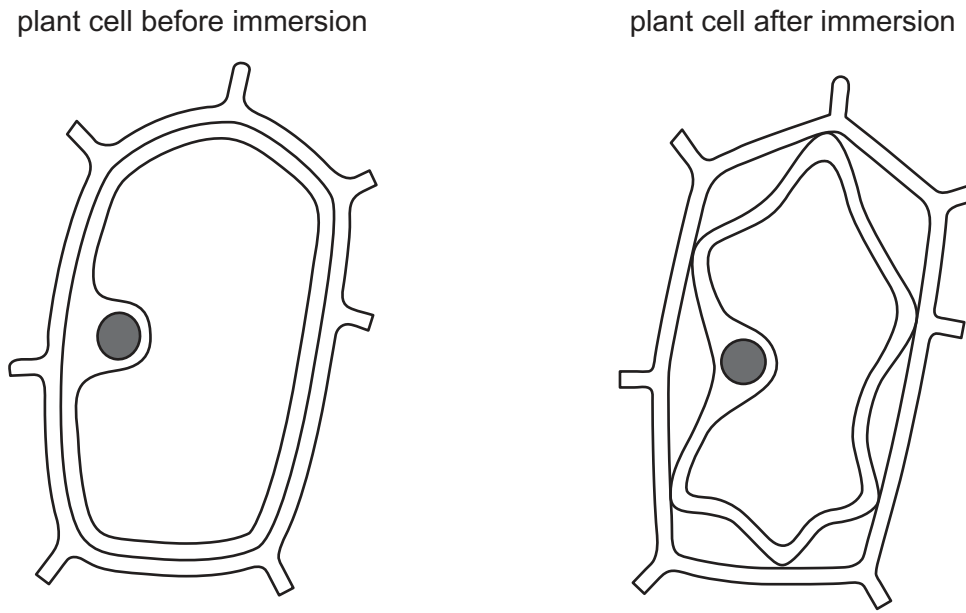

Fig. 1.2

(i) Describe two **visible** differences in the cell after immersion compared to the cell before immersion in Fig. 1.2.

- 1
 -
 - 2
 -
- [2]

(ii) Water has diffused out of the plant cell through the partially permeable membrane.

State the name of this type of diffusion.

- [1]

[Total: 9]

- 2 (a) A student has two samples of pure water in test-tubes **A** and **B**, and two samples of impure water in test-tubes **C** and **D**. A different substance is added to each test-tube as shown in Fig. 2.1.

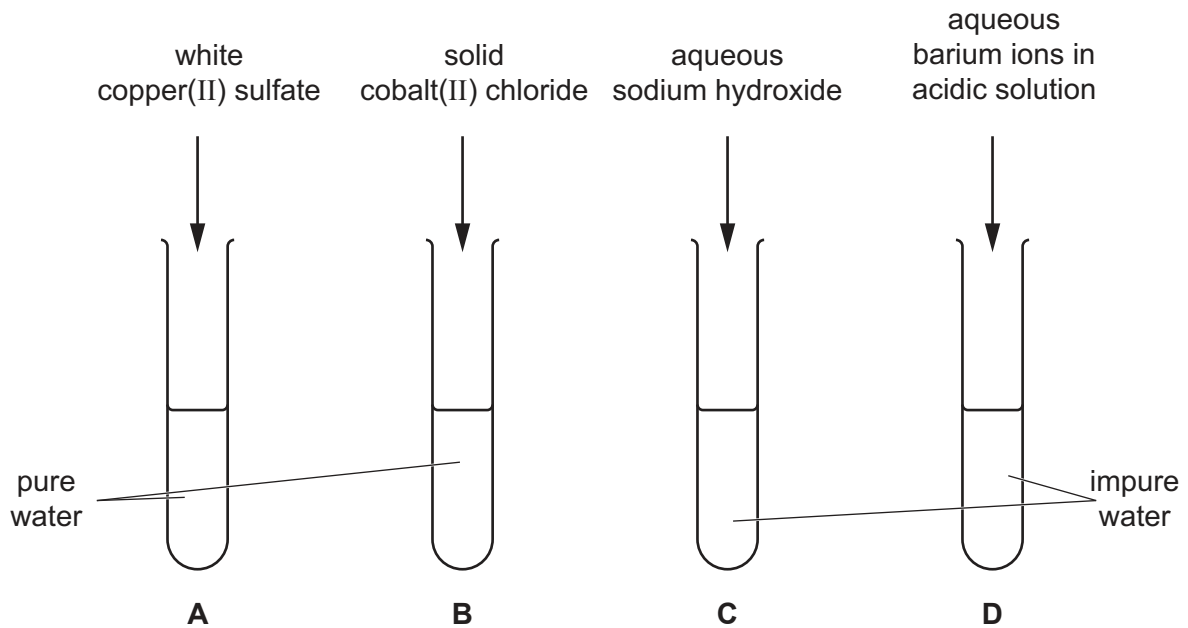

Fig. 2.1

- (i) State the colours of the solutions formed in test-tubes **A** and **B**.

A

B

[2]

- (ii) When aqueous sodium hydroxide is added to impure water in test-tube **C**, a brown precipitate is formed.

Identify the ion in the impure water that causes this change.

..... [1]

- (iii) When aqueous barium ions in acidic solution are added to test-tube **D**, a white precipitate is formed.

Identify the ion in the impure water that causes this change.

..... [1]

(b) A teacher adds a small piece of sodium to some water in a beaker, as shown in Fig. 2.2.

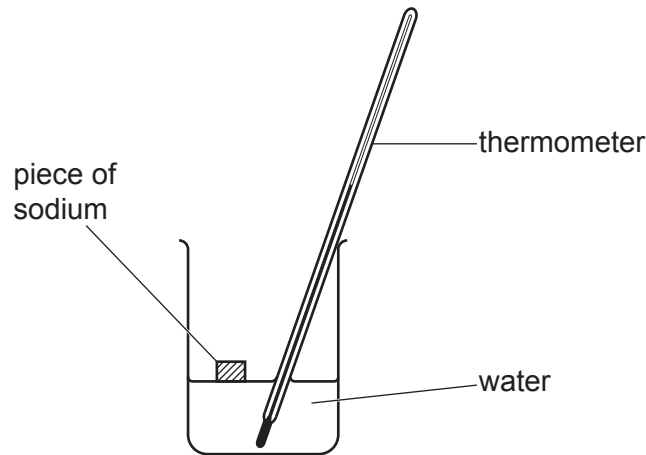

Fig. 2.2

Sodium reacts with the water in an exothermic reaction. An alkaline solution and a colourless gas are made.

(i) Describe what happens to the reading on the thermometer.

..... [1]

(ii) Complete the word equation for this reaction.

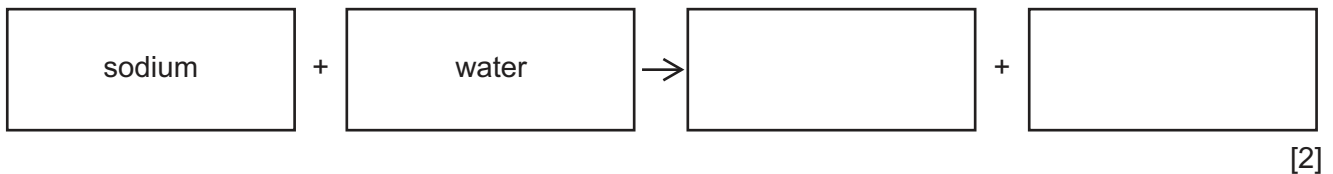

(c) Water molecules contain atoms of two non-metallic elements.

(i) State the type of chemical bond in a molecule of water.

..... [1]

(ii) Complete the dot-and-cross diagram in Fig. 2.3 to show all of the outer shell electrons in a molecule of water.



Fig. 2.3

[2]

[Total: 10]

[Turn over

3 Fig. 3.1 shows a child in a moving toy car. The car is moving forwards.

The toy car has an electric motor. The electric motor is powered by a battery.



Fig. 3.1

(a) Complete the boxes to show the useful energy changes that occur when the battery is used to make the car move.

One box has been completed for you.

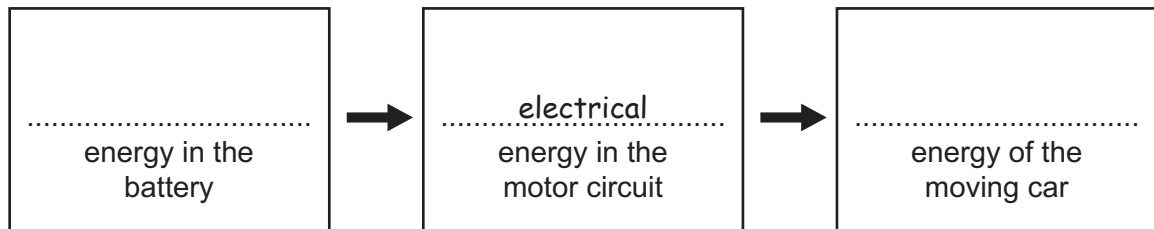

[2]

(b) The car moves forwards for 8 seconds at a constant speed of 0.7 m/s.

Calculate the distance travelled by the car.

distance = m [2]

(c) Fig. 3.2 shows the forces acting on the car moving at constant speed.

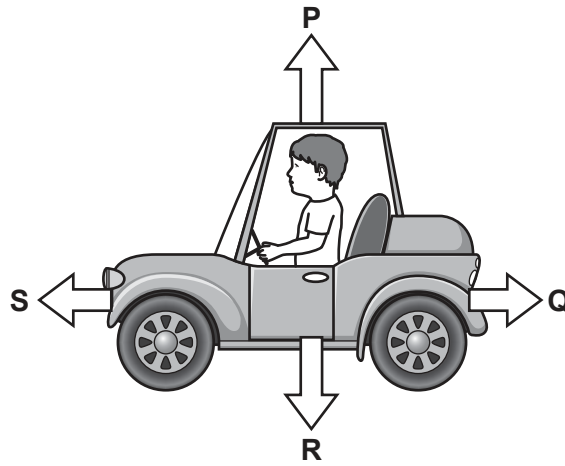

Fig. 3.2

(i) State which force, **P**, **Q**, **R** or **S**, is the weight.

.....

[1]

(ii) The weight of the car and child is 400 N.

The gravitational force on unit mass is 10 N/kg.

Calculate the mass of the car and child.

mass = kg [2]

(iii) Force **S** is increased. All the other forces remain unchanged.

Describe the effect this has on the motion of the toy car.

.....
 [1]

(iv) The child applies the car's brakes.

State which force, **P**, **Q**, **R** or **S**, is changed by applying the brakes.

Describe the change in this force.

force

change

[2]

[Total: 10]

[Turn over

- 4 (a) The boxes on the left show some of the components of blood.
 The boxes on the right show the functions of the components.
 Draw one straight line from each component to its function.

component	function
plasma	blood clotting
platelets	transport of oxygen
red blood cells	transport of soluble nutrients

[2]

- (b) Bacteria are single-celled organisms. Some bacteria infect the body causing harm.

Fig. 4.1 shows a diagram of what happens when a cut in the skin becomes infected by bacteria.

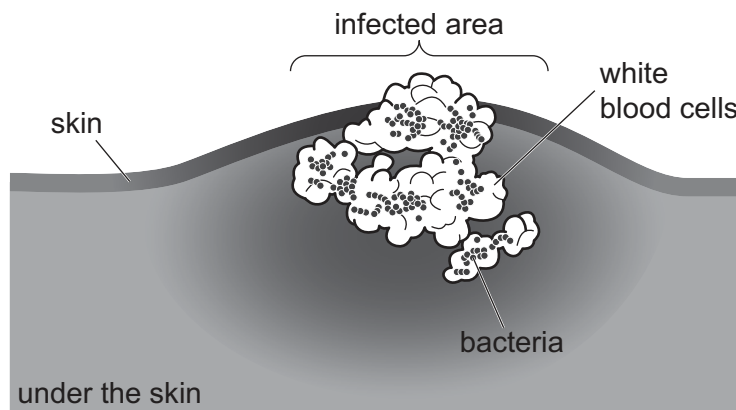

Fig. 4.1

Suggest **two** reasons why the number of white blood cells increases at the infected area.

- 1
- 2

[2]

(c) Fig. 4.2 shows a diagram of two different stages during the contraction of the human heart.

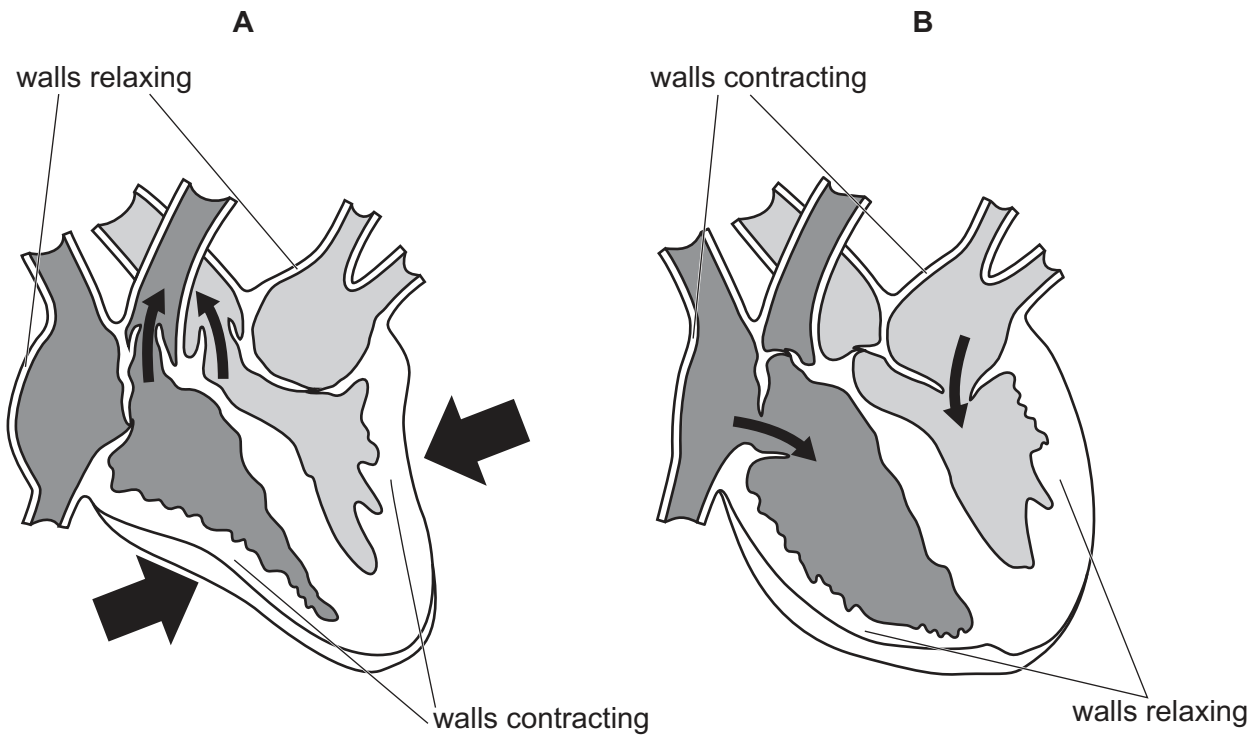

Fig. 4.2

Complete these sentences about the heart in Fig. 4.2.

Choose words from the list.

Each word can be used once, more than once or not at all.

arteries

atria

capillaries

pumps

valves

veins

ventricles

In diagram **A** the walls of the right and left are contracting.

Blood is pushed out of the heart into blood vessels called

In diagram **B** the walls of the right and left are contracting.

Blood is forced to flow in one direction by structures called

[4]

(d) A student investigates the effect of physical activity on pulse rate.

- The student measures the pulse rate of five people before physical activity.
- Each person then runs for 5 minutes, keeping their speed constant.
- The student then measures each pulse rate again.

Table 4.1 shows the results.

Table 4.1

person	pulse rate /beats per minute		
	before physical activity	after physical activity	change in pulse rate
A	70	110	40
B	68	106	38
C	73	114	41
D	76	123	47
E	69	102	

- (i) Identify the person with the lowest pulse rate **before** physical activity. [1]
- (ii) Calculate the change in pulse rate for person **E**.

change in pulse rate = beats per minute [1]

[Total: 10]

5 (a) A salt solution is made by dissolving solid salt in water.

(i) Describe the separation, arrangement and motion of particles in the **solid** salt.

separation

.....

arrangement

.....

motion

.....

[3]

(ii) An ink solution is made by dissolving a solid dye in water. The dye used to make the ink solution is a mixture of more than one coloured substance.

State a method that can be used to separate the different coloured substances in the ink.

..... [1]

(b) A concentrated sodium chloride solution is made by dissolving 35 g of solid sodium chloride in 100 cm³ of water.

(i) Suggest a mass of solid sodium chloride to make 100 cm³ of **dilute** (less concentrated) sodium chloride solution.

mass g [1]

(ii) Identify the product that forms at the anode (the positive electrode) during the electrolysis of concentrated aqueous sodium chloride using inert electrodes.

..... [1]

(c) Petroleum is a liquid fossil fuel.

(i) Name **one** solid fossil fuel.

..... [1]

(ii) State the process used to separate hydrocarbons in petroleum.

..... [1]

(iii) Describe one **difference** in the chemical properties of saturated hydrocarbons and unsaturated hydrocarbons.

.....

..... [1]

[Total: 9]

6 Fig. 6.1 shows a thermometer in a beaker of water.

A student heats the beaker of water from 20 °C to 90 °C.

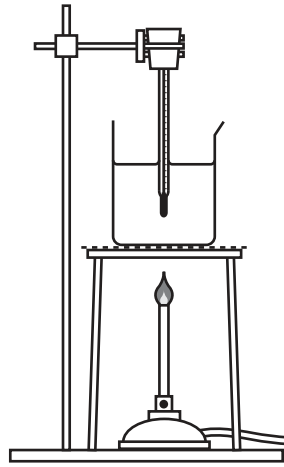

Fig. 6.1

(a) (i) A visible cloud rises above the water in the beaker.

Identify the processes that occur to form this cloud.

.....

.....

..... [2]

(ii) There is more water vapour above the water surface at 90 °C than at 20 °C.

Explain why, in terms of the motion of water molecules.

.....

.....

..... [2]

(b) Fig. 6.2 shows the student's hand near the Bunsen burner.

The student can see the blue colour of the flame.

The student's hand is heated by radiation from the flame.

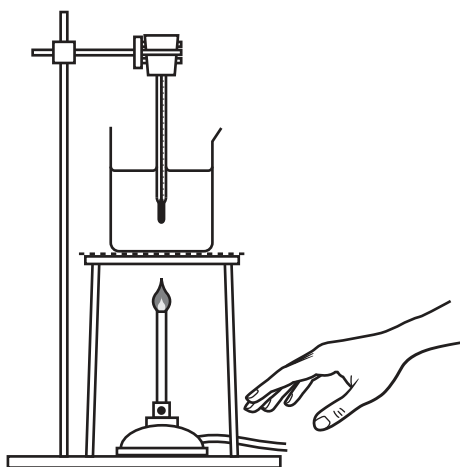

Fig. 6.2

(i) Fig. 6.3 shows an incomplete electromagnetic spectrum.

Complete Fig. 6.3 to show the quantity that increases in the direction of the arrow.

						
gamma radiation	X-ray	ultraviolet	visible light	infrared	microwaves	radio waves

Fig. 6.3

[1]

(ii) Use Fig. 6.3 to identify the part of the electromagnetic spectrum responsible for:

the student seeing the blue colour of the flame

the student's hand being heated by radiation.

[2]

(c) The Bunsen burner flame emits a constant sound with a frequency of 85 Hz. The student has healthy ears.

State whether the student is able to hear this sound.

Give a reason for your answer.

.....
 [1]

[Total: 8]

7 Fig. 7.1 is a photograph of a butterfly feeding on a lavender flower.



Fig. 7.1

(a) Table 7.1 shows information about some of the structures of the lavender flower.

Complete Table 7.1.

Table 7.1

structure	function
anther
.....	structure where pollen is transferred to during pollination
sepals

[3]

(b) Read the information in Fig. 7.2.

- The butterfly feeds on the lavender.
- Frogs eat butterflies.
- Snakes eat frogs.
- Eagles eat snakes.

Fig. 7.2

Construct a food chain using the information in Fig. 7.2.

..... [2]

(c) Lavender plants photosynthesise.

Describe the process of photosynthesis.

.....
.....
.....
.....
..... [3]

[Total: 8]

8 Part of the Periodic Table is shown in Fig. 8.1.

Group																		
I	II											III	IV	V	VI	VII	VIII	
												H hydrogen						He helium
Li lithium	Be beryllium											B boron	C carbon	N nitrogen	O oxygen	F fluorine	Ne neon	
Na sodium	Mg magnesium											Al aluminium	Si silicon	P phosphorus	S sulfur	Cl chlorine	Ar argon	
K potassium	Ca calcium	Sc scandium	Ti titanium	V vanadium	Cr chromium	Mn manganese	Fe iron	Co cobalt	Ni nickel	Cu copper	Zn zinc	Ga gallium	Ge germanium	As arsenic	Se selenium	Br bromine	Kr krypton	

Fig. 8.1

(a) Fluorine, chlorine and bromine are Group VII diatomic non-metals.

(i) Describe the trend in the physical states of the elements going down Group VII.

.....
 [1]

(ii) Explain what is meant by diatomic.

.....
 [1]

(b) Chromium, cobalt and copper are part of a collection of elements which have high densities and high melting points.

(i) State the name of this collection of elements.

..... [1]

(ii) Describe one **other** property of these elements.

..... [1]

(c) Argon is one of the Group VIII gases.

(i) State **one** use for argon.

..... [1]

(ii) Explain why the elements in Group VIII of the Periodic Table are unreactive.

Use ideas about electronic structure in your answer.

.....
.....
..... [2]

[Total: 7]

9 Fig. 9.1 shows a circuit used to supply a current to an electric motor.

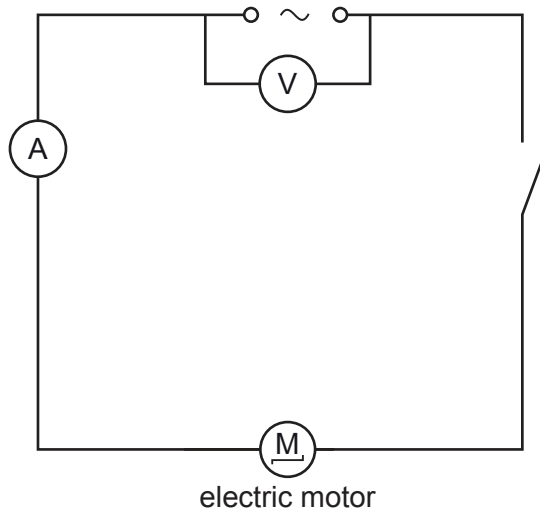

Fig. 9.1

(a) State the purpose of the component with the symbol shown.



.....
 [1]

(b) The power supply is 220V. The current in the motor is 2.4A.

Calculate the resistance of the motor.

Give the unit of your answer.

resistance = unit [3]

(c) (i) On Fig. 9.1, draw a lamp connected in parallel with the motor. [2]

(ii) The reading on the ammeter in Fig. 9.1 increases when the lamp is connected.

Explain why this happens. Use ideas about combined resistances in your answer.

.....
.....
..... [2]

(d) The electric motor has a 5A fuse inside it.

Suddenly, the fuse blows and the motor stops.

The 5A fuse is replaced with a 13A fuse.

Give **one** reason why the 13A fuse will **not** protect the motor.

.....
..... [1]

[Total: 9]

BLANK PAGE

Permission to reproduce items where third-party owned material protected by copyright is included has been sought and cleared where possible. Every reasonable effort has been made by the publisher (UCLES) to trace copyright holders, but if any items requiring clearance have unwittingly been included, the publisher will be pleased to make amends at the earliest possible opportunity.

To avoid the issue of disclosure of answer-related information to candidates, all copyright acknowledgements are reproduced online in the Cambridge Assessment International Education Copyright Acknowledgements Booklet. This is produced for each series of examinations and is freely available to download at www.cambridgeinternational.org after the live examination series.

Cambridge Assessment International Education is part of Cambridge Assessment. Cambridge Assessment is the brand name of the University of Cambridge Local Examinations Syndicate (UCLES), which is a department of the University of Cambridge.

